

SINLOON®

快速貼片開關二極管

SOT-23 BAV56

SURFACE MOUNT FAST SWITCHING DIODE (75V 0.15A)

FEATURE:

- ◆ Fast switching diode
- ◆ High Conductance
- ◆ Surface Mount Package Ideally Sited for Automatic Insertion
- ◆ For General Purpose and Switching
- ◆ Plastic Material - UL Recognition Flammability Classification 94V-0

MECHANICAL CHARACTERISTICS:

- ◆ Case: SOT-23 Molded Plastic
- ◆ Weight: 0.008 Grams (approx)
- ◆ Marking: Body top view
- ◆ Terminals: Plated leads solderable per MIL-STD-202, Method 208.
- ◆ Mounting: Position any
- ◆ Lead Free for **RoHS** Lead free version and "LF" suffix to part number.

DIMENSION:

SOT-23		
Dim	Min	Max
A	0.37	0.51
B	1.19	1.4
C	2.1	2.5
D	0.89	1.05
E	0.45	0.61
F	1.78	2.05
G	2.65	3.05
H	0.013	0.15
I	0.89	1.1
J	0.45	0.61
K	0.076	0.178

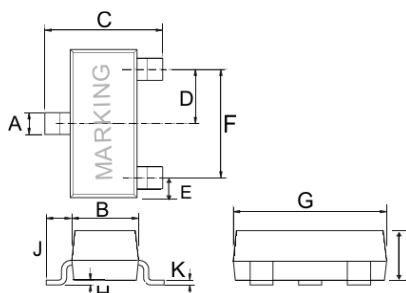

Figure



BAV56

Marking
JC

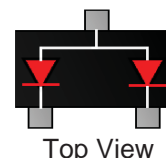

Top View

SOLDERING FOOTPRINT

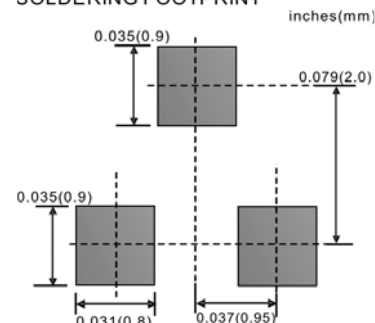

Maximum Ratings and Electrical Characteristics @ $T_A=25^\circ\text{C}$ unless otherwise specified

Characteristics	Symbol	Value	Unit
Peak Repetitive Voltage	V_{RM}	100	V
Working Peak Reverse Voltage	V_{RWM}	75	V
Peak Repetitive Reverse Voltage	V_{RRM}	75	V
DC Blocking Voltage	V_R	75	V
Forward Continuous Current (Note ¹)	I_F	300	mA
Average Rectified Output Current (Note ¹)	I_O	150	mA
Peak Forward Surge Current (Note ¹) @ $t < 1.0\mu\text{s}$	I_{FSM}	2.0	A
Power Dissipation (Note ¹)	P_d	350	mW
Typical Thermal Resistance, Junction to Ambient Air (Note ¹)	$R_{\theta JA}$	357	K/W
Operating and Storage Temperature Range	T_J, T_{STG}	-65+150	$^\circ\text{C}$

Note: ¹ Device mounted on fiberglass substrate 40x40x1.5mm

SINLOON



□ Maximum Ratings and Electrical Characteristics @ $T_A=25^\circ\text{C}$ unless otherwise specified

Characteristic	Symbol	Min.	Max.	Unit	Test Condition
Forward Voltage	V_F	----	0.855	V	@ $I_F = 10\text{mA}$
			1.0		@ $I_F = 50\text{mA}$
Reverse Leakage Current	I_R	----	2.5	μA	@ $V_R = 75\text{V}$
Junction Capacitance	C_j	----	2.0	pF	$V_R = 0\text{V}$, $f = 1.0\text{MHz}$
Reverse Recovery Time	t_{rr}	----	6.0	nS	$I_F=I_R=10\text{mA}$, $I_{RR}=0.1 \times I_R$, $R_L=100\Omega$

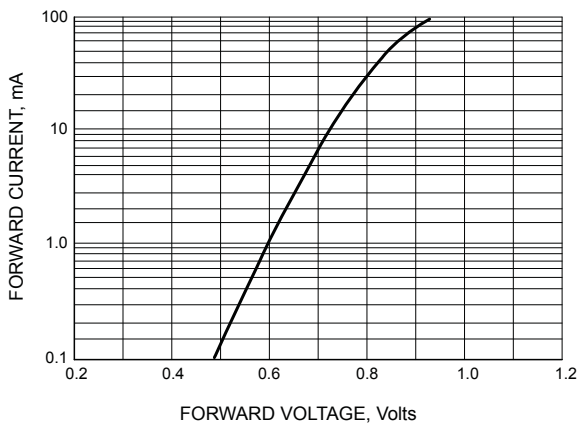

FORWARD VOLTAGE

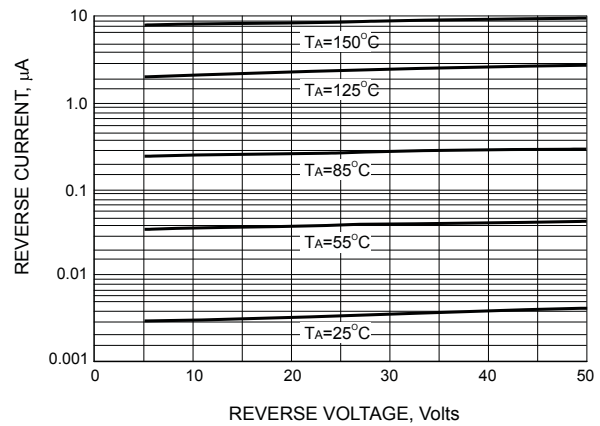

LEAKAGE CURRENT

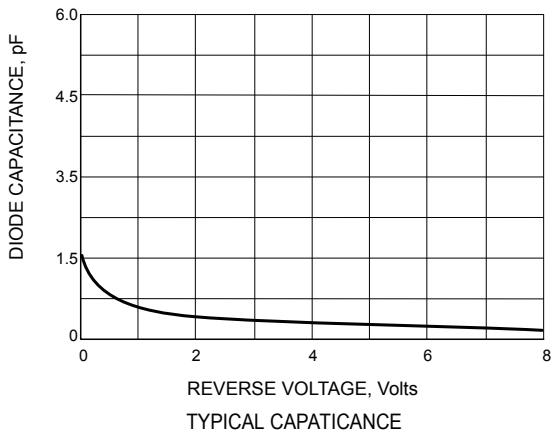

TYPICAL CAPACITANCE

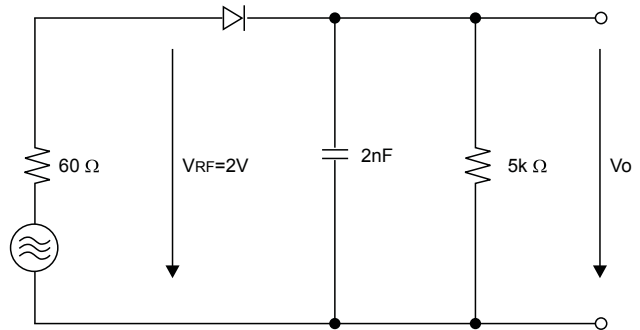

RECTIFICATION EFFICIENCY MEASUREMENT CIRCUIT

SINLOON

SINLOON®

快速貼片開關二極管

SOT-23 BAV56

SURFACE MOUNT FAST SWITCHING DIODE (75V 0.15A)

COMMON PACKING INFORMATION:

Product Number:	Package Type	Packing Quantity	Carton Quantity	Apporx Gross Weight
BAV56	SOT-23	3000 Tape & Reel	150,000 Ctn	10 Kg

Reel Diameter (mm)	Quantity (Pcs)	Inner Box Size (mm)	Carton Size (mm)
178	3000	L: 187 x W:187 x H: 65	L:390 x W:240 x H:420

PACKAGE

Fig-1



Q'ty: 3000/Reel

Fig-2



Q'ty: 30,000/Inner Box

Fig-3



Q'ty: 150,000 / Carton

SINLOON

美隆電子產品規格特性參數的改變或更新,將不會另行通知。

Mayloon characteristic parameters of electronic product specification changes or updates without prior notice.

