

SINLOON®

快速貼片雙晶開關二極管

SOT-323 BAV56W

SURFACE MOUNT FAST SWITCHING DIODE (75V 0.15A)

FEATURE:

- ◆ Fast switching diode
- ◆ High Conductance
- ◆ Surface Mount Package Ideally Sited for Automatic Insertion
- ◆ For General Purpose and Switching
- ◆ Plastic Material - UL Recognition Flammability Classification 94V-0

MECHANICAL CHARACTERISTICS:

- ◆ Case: SOT-323 Molded Plastic
- ◆ Weight: 0.006 Grams (approx)
- ◆ Marking: Body top view
- ◆ Terminals: Plated leads solderable per MIL-STD-202, Method 208.
- ◆ Mounting: Position any
- ◆ Lead Free for **RoHS** Lead free version and "LF" suffix to part number.

DIMENSION: mm

SOT-323		
Dim	Min	Max
A	0.3	0.51
B	1.11	1.4
C	2	2.5
D	0.65	0.65
E	0.3	0.61
F	1.2	2.05
G	1.8	3.05
H	0.1	0.11
I	0.89	1.1
J	0.25	0.25
K	0.05	0.15

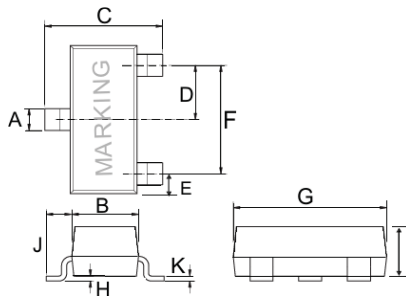

Figure



BAV56W

Marking
JC

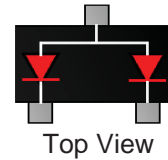

SOT-323 Recommended Footprint

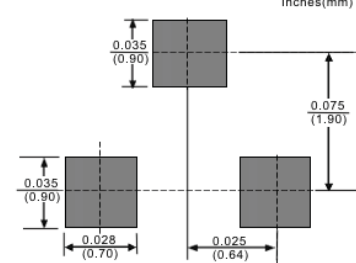

Maximum Ratings and Electrical Characteristics @T_A=25°C unless otherwise specified

Characteristics	Symbol	Value	Unit
Non-Repetitive Peak Repetitive Voltage	V _{RM}	100	V
Working Peak Reverse Voltage	V _{RWM}	75	V
Peak Repetitive Reverse Voltage	V _{RRM}	75	V
DC Blocking Voltage	V _R	75	V
Forward Continuous Current (Note ¹)	I _F	300	mA
Average Rectified Output Current (Note ¹)	I _O	150	mA
Peak Forward Surge Current (Note ¹) @t<1.0μs	I _{FSM}	2.0	A
Power Dissipation (Note ¹)	P _d	200	mW
Typical Thermal Resistance, Junction to Ambient Air (Note ¹)	R _{θJA}	625	K/W
Operating and Storage Temperature Range	T _J , T _{STG}	-65+150	°C

Note: ¹ Device mounted on fiberglass substrate 40x40x1.5mm

SINLOON





快速貼片雙晶開關二極管

SOT-323 BAV56W

SURFACE MOUNT FAST SWITCHING DIODE (75V 0.15A)

Maximum Ratings and Electrical Characteristics @T_A=25°C unless otherwise specified

Characteristic	Symbol	Min.	Max.	Unit	Test Condition
Forward Voltage	V _F	----	0.855	V	@I _F = 10mA
			1.0		@I _F = 50mA
Reverse Leakage Current	I _R	----	2.5	μA	@V _R = 75A
Junction Capacitance	C _J	----	2.0	pF	V _R = 0V, f = 1.0MHz
Reverse Recovery Time	t _{rr}	----	6.0	nS	I _F =I _R =10mA, I _{RR} =0.1x I _R , R _L =100Ω

Graphical Data

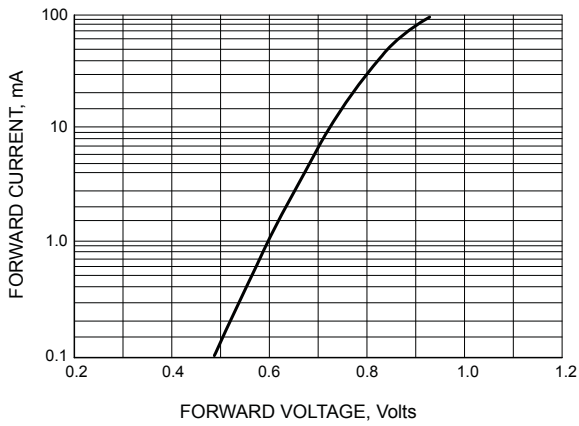

FORWARD VOLTAGE

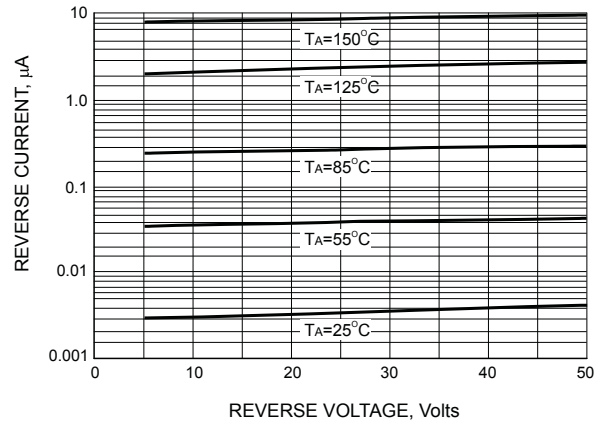

LEAKAGE CURRENT

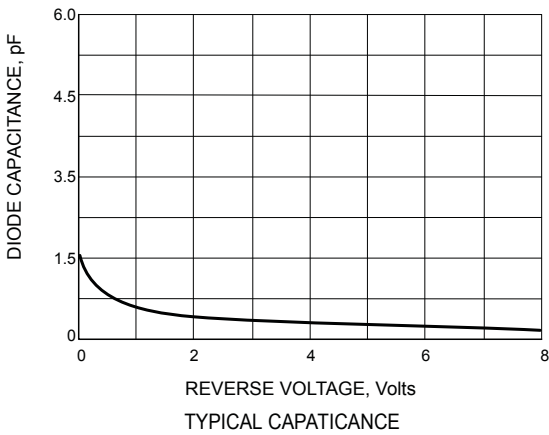

TYPICAL CAPACITANCE

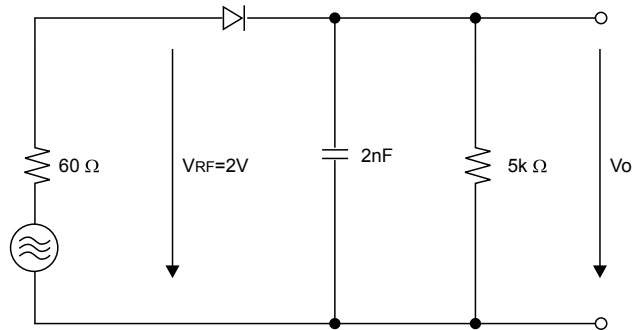

RECTIFICATION EFFICIENCY MEASUREMENT CIRCUIT

SINLOON



SINLOON®

快速貼片雙晶開關二極管

SOT-323 BAV56W

SURFACE MOUNT FAST SWITCHING DIODE (75V 0.15A)

COMMON PACKING INFORMATION:

Product Number:	Package Type	Packing Quantity	Carton Quantity	Apporx Gross Weight
BAV56W	SOT-23	3000 Tape & Reel	150,000 Ctn	10 Kg

Reel Diameter (mm)	Quantity (Pcs)	Inner Box Size (mm)	Carton Size (mm)
178	3000	L: 187 x W:187 x H: 65	L:390 x W:240 x H:420

PACKAGE

Fig-1

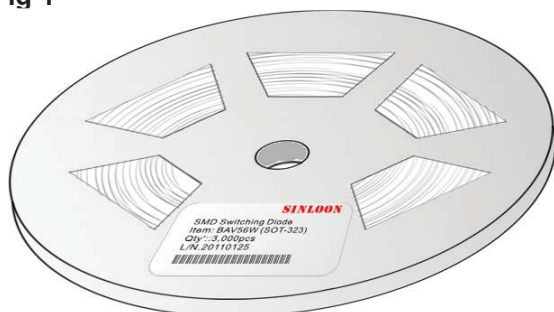

Q'ty: 3000/Reel

Fig-2



Q'ty: 30,000/Inner Box

Fig-3



Q'ty: 150,000 / Carton

SINLOON

美隆電子產品規格特性參數的改變或更新,將不會另行通知。

Mayloon characteristic parameters of electronic product specification changes or updates without prior notice.

