

Small Signal Switching Chip Diode

FEATURE

Silicon Epitaxial Planar Diode.

Fast switching dual chip diode with anode to cathode.

This diode is also available in other configurations figuration including single with type designation CDBAW56, a dual common anode with type designation CDBAV70, and a dual common cathode with type designation CDBAV99

Lead (Pd) - free component.

Marking: BAW56



Value: CDBAW56

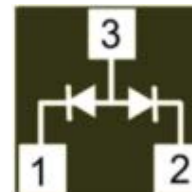

Case: SOT23 Plastic Case  
Weight: approx. 21mg

DIMENSION:

(mm)	CDBAW56
L	3.1 ± 0.2
W	2.6 ± 0.2
H	0.95 ± 0.2
T	0.75 ± 0.2
C	0.8 ± 0.1

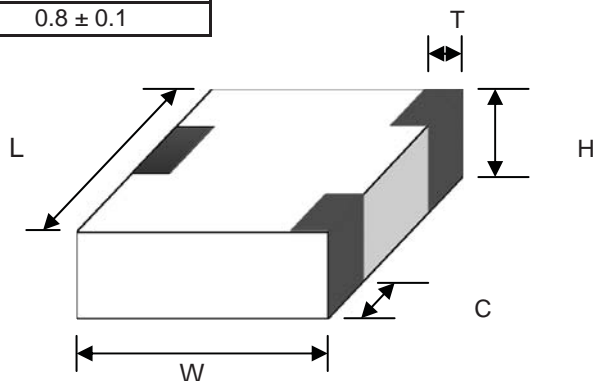

Maximum Ratings & Electrical Characteristics  $T_{amb} = 25^{\circ}C$ , unless otherwise noted

Parameter	Symbol	Value	Unit
Device marking code		CDBAW56	
Non repetitive peak reverse voltage	$V_{RM}$	100	V
Repetitive pead reverse voltage	$V_R = V_{RRM}$	70	V
Forward continuous current	$I_F$	200	mA
Non repetitive peak forward current	$I_{FSM}$	$tp = 1 \text{ us}$	2.0
		$tp = 1 \text{ ms}$	1.0
		$tp = 1 \text{ s}$	0.5
Average forward current	$I_{FSM}$	150 <sup>1)</sup>	mA
Power dissipation	$P_{TOT}$	300 <sup>1)</sup>	mW
Forward voltage	$V_F$	$I_F = 1\text{mA}$	715
		$I_F = 10\text{mA}$	855
		$I_F = 50\text{mA}$	1000
		$I_F = 150\text{mA}$	1250
Leakage current	$I_R$	$V_R = 70\text{V}$	2.5
		$V_R = 70\text{V}, T_j = 150^{\circ}C$	50
		$V_R = 25\text{V}, T_j = 150^{\circ}C$	30
Thermal resistance junction to ambient air	$R_{thJA}$	430 <sup>1)</sup>	K/W
Junction temperature	$T_j$	150	$^{\circ}C$
Storage temperature range	$T_{stg}$	- 55 to + 150	$^{\circ}C$
Diode capacitance ( $V_F = V_R = 0, f = 1\text{MHz}$ )	$C_{tot}$	2	pF
Reverse Recovery time ( $I_F = 10\text{mA}$ to $I_R = 1\text{mA}, V_R = 6\text{V}, R_L = 100\Omega$ )	$T_{rr}$	6	ns

<sup>1)</sup> Valid provided that electrodes are kept at ambient temperature.



Small Signal Switching Chip Diode

Typical Characteristics

(Tamb=25°C, unless otherwise specified)

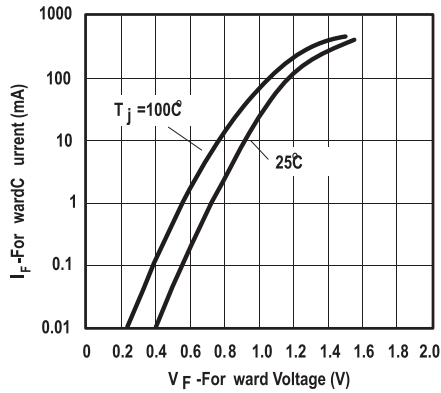

Figure1. Forward Current vs. Forward Voltage

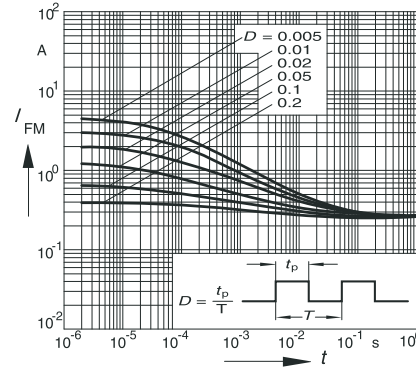

Figure2. Peak forward current  $I_{FM} = f(t_p)$

Suggested thermal profiles for soldering processes

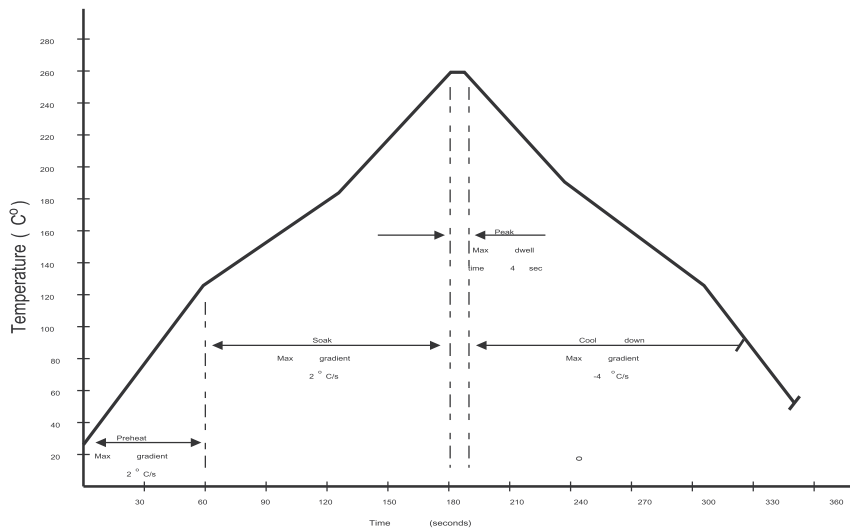

Fig.1 Typical Wave Soldering Thermal Profile

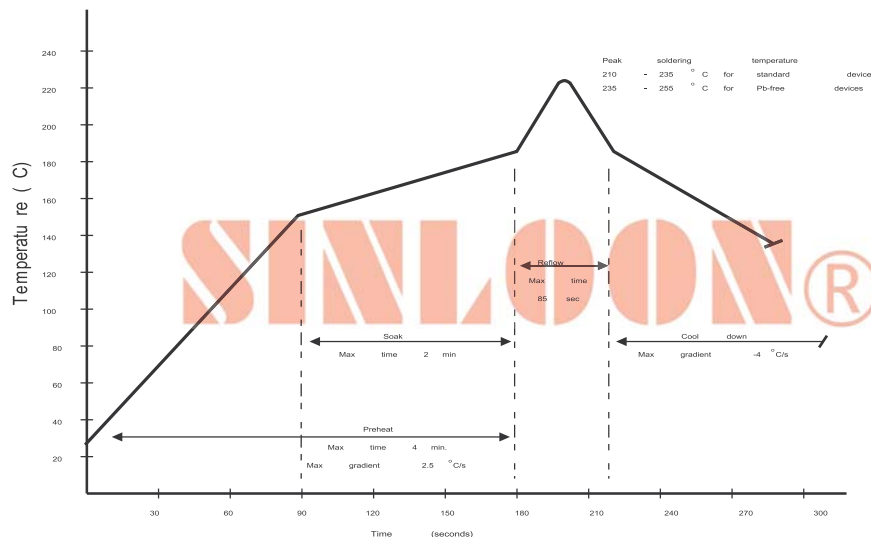
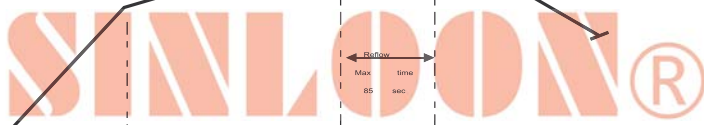

Fig.2 Typical IR Reflow Soldering Thermal Profile



**TEST CHARACTERISTICS**

Test Item	Test Condition	Requirement
Solder ability	Sn bath at 245±5 °C for 2±0.5s	>95% area tin covered
Resistance to Soldering Heat	Sn bath at 260±5 °C for 10±2s	V <sub>F</sub> , V <sub>Z</sub> & I <sub>R</sub> within spec., no mechanical damage.
Humidity Steady State	At 85°C 85% 85RH for 168hrs.	V <sub>F</sub> , V <sub>Z</sub> & I <sub>R</sub> within spec.
Continue Forward Operating Life	At 25°C I <sub>F</sub> =I <sub>o</sub> ±10% for 100hrs.	V <sub>F</sub> , V <sub>Z</sub> & I <sub>R</sub> within spec.
Hi-Temperature Reverse Bias	At 150°C V <sub>R</sub> =0.8V <sub>R</sub> Rated for 1000hrs.	V <sub>F</sub> , V <sub>Z</sub> & I <sub>R</sub> within spec.
Thermal Shock	-55±5°C/5min to 150±5°C/min for 10cycles.	V <sub>F</sub> , V <sub>Z</sub> & I <sub>R</sub> within spec.
Banding Strength	Bending up to 2mm for 1 cycle.	V <sub>F</sub> , V <sub>Z</sub> & I <sub>R</sub> within spec., no mechanical damage.

**APPLICATIONS**

- ◆ Function: Fast Switching
- ◆ Soldering Condition.

Recommended Profile Condition	Sn-Pb Soldering	Lead-Free Soldering	Wave Soldering
Pre-up rate (from pre-heat stage)	<3°C/s.	<3°C/s.	ΔT<150°C
Pre-heat temperature & Time	100-150°C , 60-120s.	150-200°C , 60-180s.	100-150°C , 60-120s.
Soldering Temperature & Time	183°C 60-150s.	217°C 60-150s.	260±5°C 5±2s
Peak Temperature	230±5°C	245±5°C	260±5°C
Time within 5°C of peak temperature	10-30s.	20-40s.	-
Ramp-down rate	<6°C/s.	<6°C/s.	<6°C/s.
Time 25°C to peak temperature	<6min	<8min	-

Manual Soldering: Approx 350°C for 3s, avoid solder iron tip direct the components body.

- ◆ Storage Condition: Product termination solder ability can degrade due to temperature and humidity or chemical environment, Storage condition must be an ambient temperature of <40°C and ambient humidity of <80%RH, and free from chemical.

**ENVIRONMENTAL CHARACTERISTICS**

Product	Hazardous Substance or Element/ppm						Packing Quality	Reel Size	Tape
	Pb	Cd	Hg	Cr <sup>6+</sup>	PBB	PBDE			
CDBAW56	<1000	<100	<1000	<1000	<1000	<1000	3K Reel	7"	Embossed

**Mounting Pad Layout**

Typ.(mm)	CDBAW56
W1	2.0
C1	0.9
C2	0.9
F1	1.14
F2	1.14

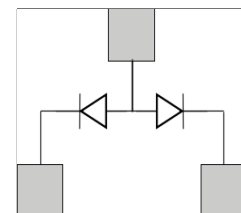
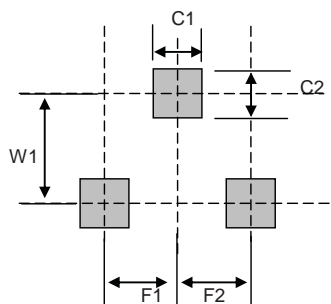

**Device Outlook**

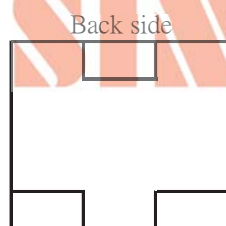
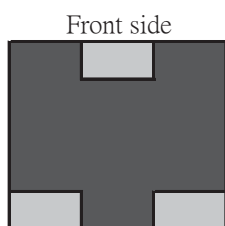

**Packing Reel Type**

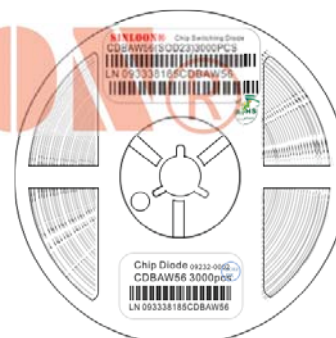

**Small Signal Switching Chip Diode**

**PACKAGING (Figure)**

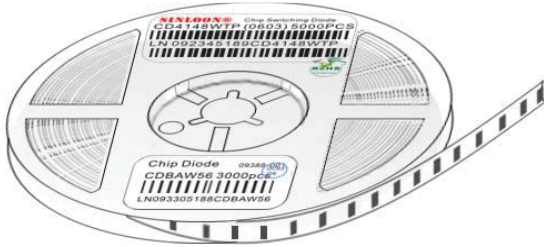

Plastic reel front side

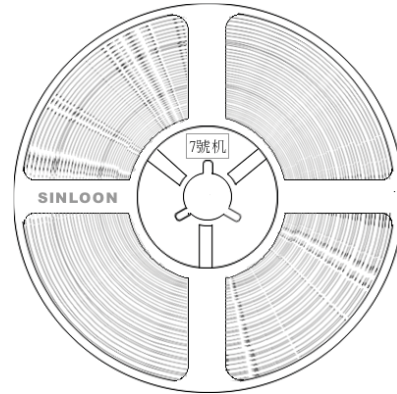

Plastic reel back side

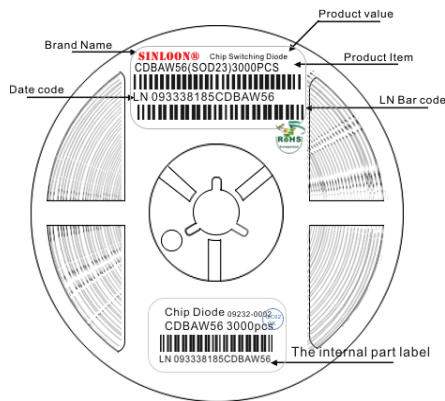

Reel label / 3K pcs

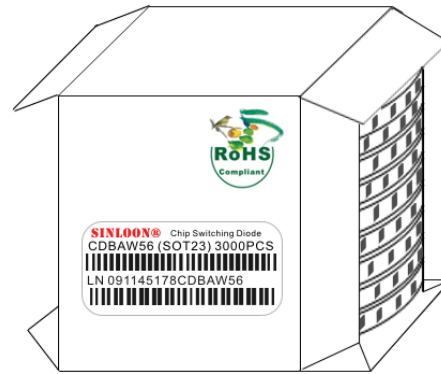

In box package / 30K pcs

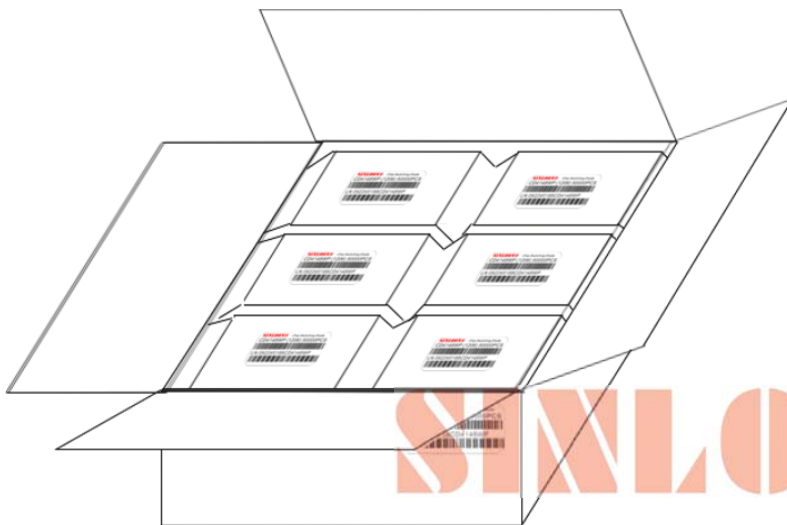

Carton package / 180K pcs

