

SINLOON®

平面灌膠式空芯線圈電感
Turns: 6 ~ 10

TYPE: AM7030 Series
SMD Flat Top Air Core Inductor

□ Feature

- ◆ High frequency (高頻)
- ◆ Highest possible SRF as well as excellent Q values (高共振頻率及高品質因素)
- ◆ The constitutive property is good and easy to operate (結構性佳、使用方便)

□ Applications (用途)

- ◆ Pager, Cordless phone & High Freq. Communication Products (呼叫器、行動電話及高頻通訊類產品)
- ◆ Intercom, CATV (對講機、CATV)

□ Ordering

Product Identification of Part Number (i.e. : AM7030-06T)
AM7030 SMD Flat Top Air Core Inductors Size
06 Turns (圈數)

□ Figure



□ Package

Packaging Tape Reel 178/330mm diameter
reel EIA ST 481-1
Quantity : 700 piece reel / 178mm
2000 piece reel / 330mm

□ Configurations & Dimension

TYPE	A	B	C	D	E	F	G	H	I	J	Unit: mm
AM7030	6.0±0.3	2.5±0.2	2.6±0.2	5.8±0.4	0.7±0.3	2.8	3.3	7.4	4.9	1.3	

* Design as Customers Requested Specifications (可依特殊需求設計生產)

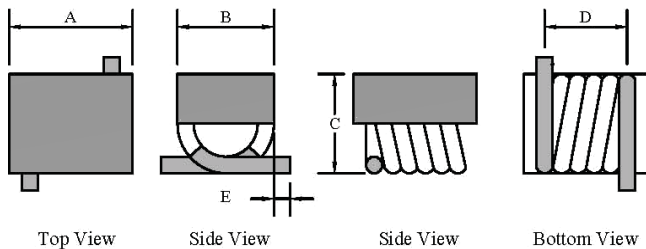

Land Pattern

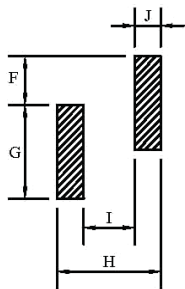

□ Reel Type Dimension

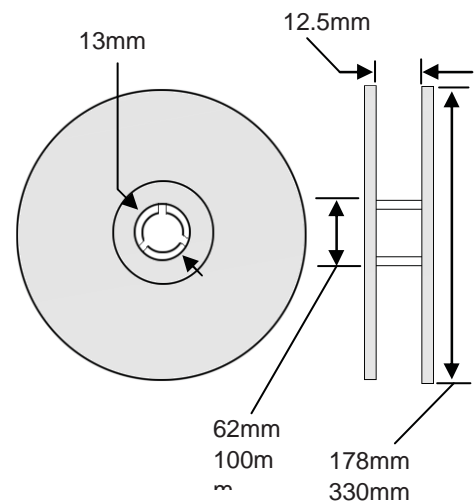

□ Electrical Characteristics for AM7030 Series

產品規格型號 Ordering Part Number	圈數 Turns	電感值(L) Inductance L (nH)	品質因數 Q (min)	測試頻率 Test Freq (MHz)	共振頻率 SRF(MHz) (min)
AM7030-06T	6	17.5±10%	100	150	>2.2
AM7030-07T	7	22.0±10%	100	150	>2.0
AM7030-08T	8	28.0±10%	100	150	>1.8
AM7030-09T	9	35.5±5%	100	150	>1.2
AM7030-10T	10	43.5±5%	100	150	>1.0

※美隆公司產品規格及其特性參數的改變或更新恕不另行通知。

※Mayloon characteristic parameters of electronic product specification changes or updates without notice to improve

