

Approval

Manufacturer:

Mayloon Electronic Co., Ltd.,
Falt E, 17/F. Houston Ind., Bldg.,
32-40 Wang Lung St., Tsuen Wan, HK.
Tel: 0852-2408 9788 Fax: 852-2406 9983

Customer:

Approved By:	Checked By:	Prepared By :

Approved By:	Examined By:	Tested By :

Company's Stamp	
-----------------	--

Company's Stamp	
-----------------	--

Approval No. : _____

Product : NTC THERMISTOR

Mayloon Part No. : SMD03-103 F 3435F

Customer's Part No. : _____

Specifications : R25 10,000 Ω ± 1 %

B25-85 3435 °K ± 1 %

Date : _____

Specification of SMD Chips Thermistor

◆ **PART NO. :** [SMD03-103 F 3435 F](#)

◆ **CHIP DIMENSIONS**

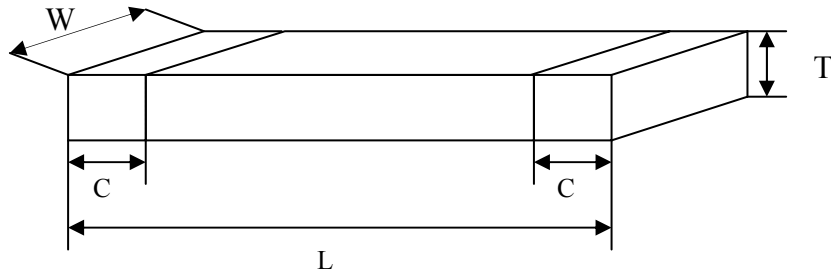

Item	L(mm)	W(mm)	T(mm)	C(mm)
1608 (0603)	1.60 ±0.05	0.80 ±0.05	0.95 ±0.10	0.40±0.20

◆ **CHIP STRUCTURE**

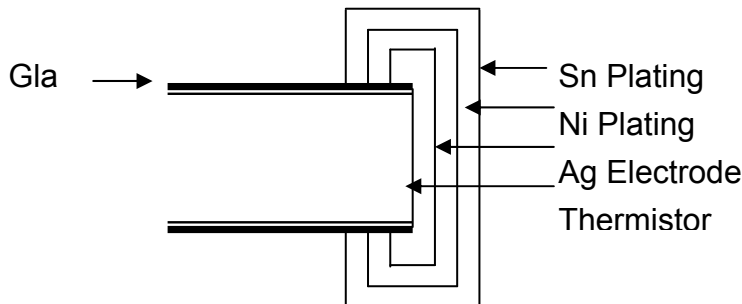

◆ **ELECTRICAL CHARACTERISTICS**

Style	Symbol	Condition	Specification
Resistance at 25°C	R ₂₅	T = 25 ± 0.1°C	10K Ω ± 1 %
B Constant	B	25°C to 85°C	3435 °K ± 1 %
Thermal Time Constant	T	T = 25 ± 0.1°C	Approx. 5 sec
Thermal Dissipation Constant	C	T = 25 ± 0.1°C	Approx. 3.5 mW/°C
Maximum Power Rating*	P _w	T = 25 ± 0.1°C	350 mW
Operation Temp. Range	--	--	-40°C ~ 125°C

*Maximum Power Rating = Thermal Dissipation Constant × (125°C-25°C)

◆ RELIABILITY TEST

PERFORMANCE	TEST METHOD	APPRAISE
Life	MIL – STD – 202F , Method 108A 1000 hours at 125°C NTC WV intermittent	Within ±3 %
Humidity	MIL – STD – 202F , Method 103B 1000 hours at Temperature: 40°C Humidity: 95%	Within ±3 %
Thermal Shock	MIL – STD – 202F , Method 107 10 cycles, -40°C to +125°C	Within ±3 %
Solderability	MIL – STD – 202F , Method 208 235°C for 2 seconds	95% min. coverage
Resistance to Soldering Heat	MIL – R – 55342D , Para 4.7.7 Soldered to test board at 260°C for 10 seconds	Within ±3 %
Bending Strength	JIS C 5202 6.1.4 Pressurizing rod at a rate at 1mm/sec for 1mm	Within ±3 %
Resistance to flexure of Substrate	JIS C 5202 6.2.1 Pressurizing force shall be 3kg (min.)	Over 3 kg
Insulation Resistance	MIL – STD – 202F , Method 302 DC 250V For 10 seconds	Over 1000MΩ
Dielectric Withstand Voltage	MIL – STD – 202F , Method 301 DC 250V For 10 seconds	Not Short

◆ VOLTAGE – CURRENT CURVE

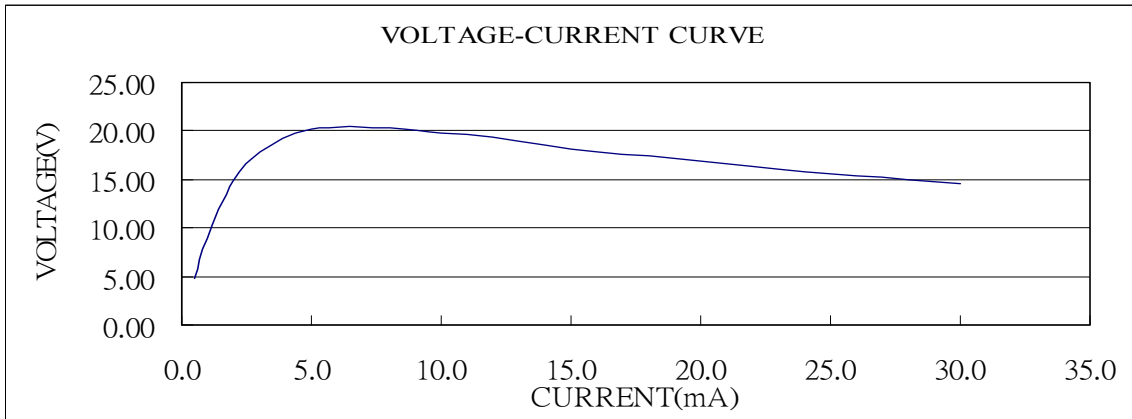

◆ RESISTANCE – TEMP CURVE

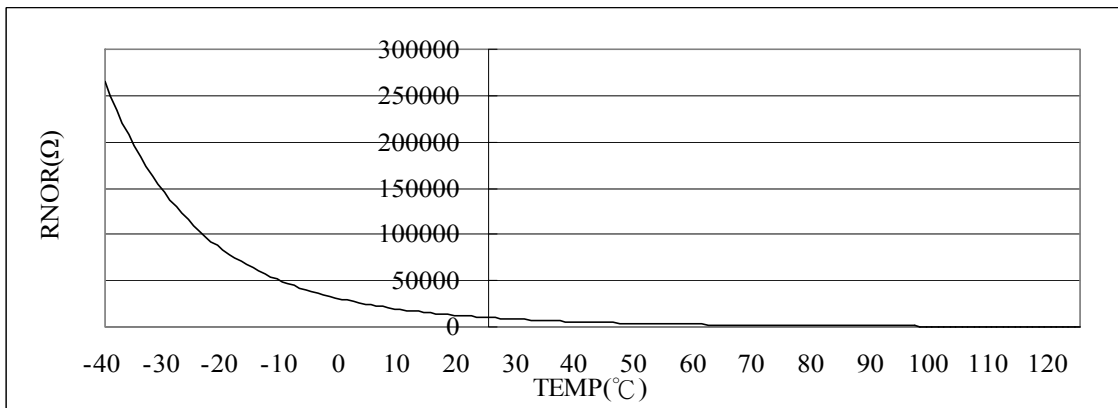

◆ REFLOW SOLDERING PROFILE

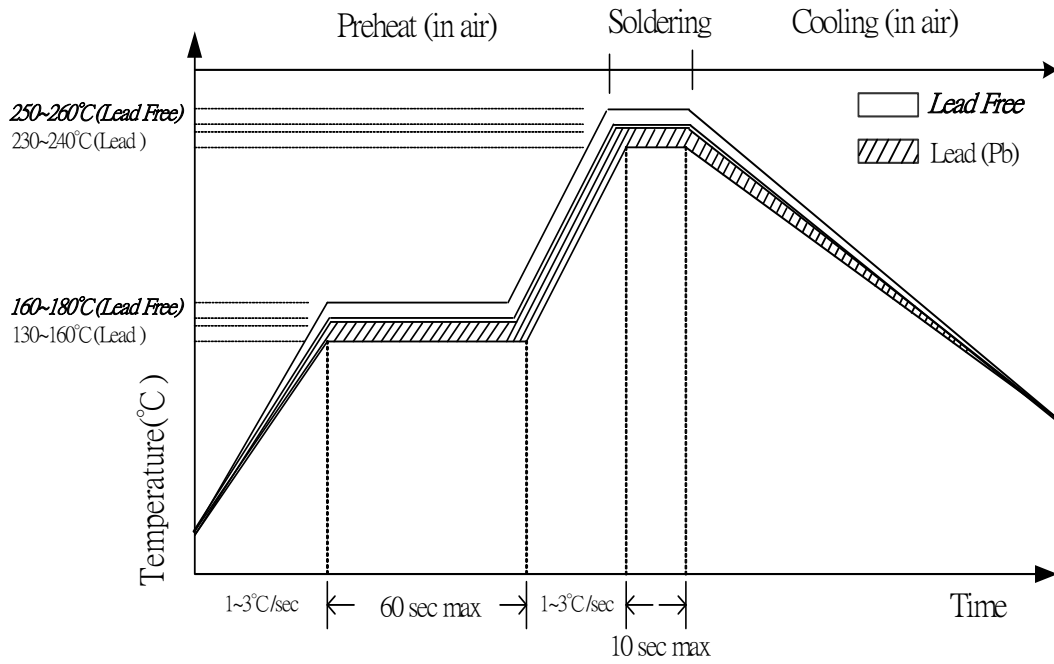

◆ TAPING DIMENSIONS

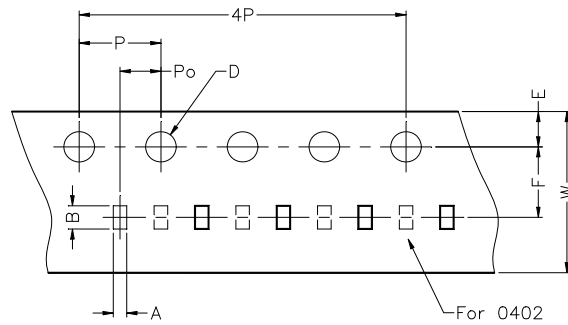

Unit: mm

Dimension	0805	0603	0402
A	1.50 ± 0.05	1.08 ± 0.05	0.66 ± 0.03
B	2.30 ± 0.05	1.85 ± 0.05	1.15 ± 0.03
W	8.00 ± 0.05	8.00 ± 0.05	8.00 ± 0.05
D	1.50 ± 0.10	1.50 ± 0.10	1.50 ± 0.10
E	1.75 ± 0.05	1.75 ± 0.05	1.75 ± 0.05
F	3.50 ± 0.05	3.50 ± 0.05	3.50 ± 0.05
P	4.00 ± 0.05	4.00 ± 0.05	4.00 ± 0.05
P _o	2.00 ± 0.05	2.00 ± 0.05	2.00 ± 0.05
4P	16.00 ± 0.05	16.00 ± 0.05	16.00 ± 0.05

◆ **REEL DIMENSIONS**

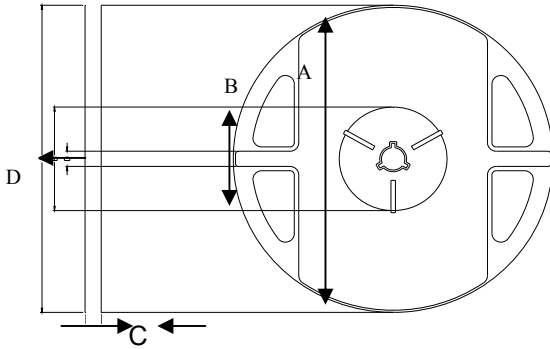

Unit: mm

Item	A	B	C	D
Dimension	178.0 ±1.0	60.0 ±1.0	9.0 ±0.1	13.0 ±0.1

◆ **ORDERING INFORMATION**

SMD 03 103 F 3435 F
 ① ② ③ ④ ⑤ ⑥

1. Series SMD Thermistor. (TH - Lead (Pb) ; TF - Lead Free)
2. Dimension : 06 (1206) , 05 (0805) , 03 (0603) , 02 (0402)
3. Resistance : 103 = $10 \times 10^3 = 10,000$ ohm
4. R Tolerance : F:±1% ; G:±2% ; H:±3% ; J:±5% ; K:±10%
5. B value : 3125, 3435 , 3550, 3700, 4100,etc.
6. B Tolerance : F:±1% ; G:±2% ; H:±3%

● **ACCESSORY : RESISTANCE-TEMPERATURE CHARACTERISTICS**

Resistance-Temperature Characteristics

Part No. :

SMD03-103 F 3435F

R : 10,000 ohms ± 1%

B : 3435 °K ± 1%

Temperature (°C)	Resistance (Ω)			Temp. Coef. (%/°C)	Resist. Tolerance (%)		Temp. Tolerance (°C)	
	MIN.	CENTER	MAX.		MIN.	MAX.	MIN.	MAX.
-40	181159	188442	195998	-5.41	-3.86	4.01	-0.74	0.71
-39	171739	178547	185606	-5.38	-3.81	3.95	-0.74	0.71
-38	162859	169224	175820	-5.35	-3.76	3.90	-0.73	0.70
-37	154486	160438	166602	-5.32	-3.71	3.84	-0.72	0.70
-36	146587	152154	157917	-5.29	-3.66	3.79	-0.72	0.69
-35	139135	144343	149730	-5.26	-3.61	3.73	-0.71	0.69
-34	132101	136974	142012	-5.22	-3.56	3.68	-0.70	0.68
-33	125460	130020	134733	-5.19	-3.51	3.62	-0.70	0.68
-32	119189	123457	127865	-5.16	-3.46	3.57	-0.69	0.67
-31	113265	117260	121384	-5.14	-3.41	3.52	-0.68	0.66
-30	107666	111407	115267	-5.11	-3.36	3.46	-0.68	0.66
-29	102375	105878	109490	-5.08	-3.31	3.41	-0.67	0.65
-28	97371	100652	104034	-5.05	-3.26	3.36	-0.67	0.65
-27	92639	95713	98878	-5.02	-3.21	3.31	-0.66	0.64
-26	88162	91042	94006	-4.99	-3.16	3.26	-0.65	0.63
-25	83926	86624	89400	-4.96	-3.11	3.20	-0.65	0.63
-24	79916	82444	85044	-4.93	-3.07	3.15	-0.64	0.62
-23	76118	78488	80923	-4.90	-3.02	3.10	-0.63	0.62
-22	72522	74743	77024	-4.87	-2.97	3.05	-0.63	0.61
-21	69115	71197	73334	-4.85	-2.92	3.00	-0.62	0.60
-20	65886	67838	69840	-4.82	-2.88	2.95	-0.61	0.60
-19	62825	64655	66532	-4.79	-2.83	2.90	-0.61	0.59
-18	59922	61638	63397	-4.76	-2.78	2.85	-0.60	0.58
-17	57169	58779	60427	-4.74	-2.74	2.80	-0.59	0.58
-16	54558	56067	57612	-4.71	-2.69	2.76	-0.59	0.57
-15	52079	53495	54944	-4.68	-2.65	2.71	-0.58	0.57
-14	49727	51054	52412	-4.66	-2.60	2.66	-0.57	0.56
-13	47493	48738	50012	-4.63	-2.56	2.61	-0.56	0.55
-12	45371	46539	47733	-4.60	-2.51	2.57	-0.56	0.55

-11	43355	44452	45571	-4.58	-2.47	2.52	-0.55	0.54
-10	41440	42468	43518	-4.55	-2.42	2.47	-0.54	0.53
-9	39620	40584	41568	-4.53	-2.38	2.42	-0.54	0.53
-8	37889	38794	39716	-4.50	-2.33	2.38	-0.53	0.52
-7	36243	37092	37957	-4.47	-2.29	2.33	-0.52	0.51
-6	34677	35473	36285	-4.45	-2.25	2.29	-0.51	0.50
-5	33187	33934	34695	-4.42	-2.20	2.24	-0.51	0.50
-4	31769	32470	33183	-4.40	-2.16	2.20	-0.50	0.49
-3	30419	31076	31745	-4.37	-2.12	2.15	-0.49	0.48
-2	29133	29750	30377	-4.35	-2.07	2.11	-0.48	0.48
-1	27909	28488	29075	-4.32	-2.03	2.06	-0.48	0.47
0	26743	27285	27836	-4.30	-1.99	2.02	-0.47	0.46
1	25631	26140	26656	-4.28	-1.95	1.98	-0.46	0.46
2	24571	25049	25532	-4.25	-1.90	1.93	-0.45	0.45
3	23561	24009	24462	-4.23	-1.86	1.89	-0.45	0.44
4	22598	23017	23442	-4.20	-1.82	1.85	-0.44	0.43
5	21679	22072	22470	-4.18	-1.78	1.80	-0.43	0.43
6	20802	21171	21543	-4.16	-1.74	1.76	-0.42	0.42
7	19966	20311	20660	-4.14	-1.70	1.72	-0.42	0.41
8	19167	19490	19817	-4.11	-1.66	1.68	-0.41	0.40
9	18404	18707	19013	-4.09	-1.62	1.63	-0.40	0.40
10	17676	17960	18246	-4.07	-1.58	1.59	-0.39	0.39
11	16981	17246	17513	-4.04	-1.54	1.55	-0.38	0.38
12	16316	16564	16814	-4.02	-1.50	1.51	-0.38	0.37
13	15681	15913	16147	-4.00	-1.46	1.47	-0.37	0.36
14	15074	15291	15509	-3.98	-1.42	1.43	-0.36	0.36
15	14493	14696	14900	-3.96	-1.38	1.39	-0.35	0.35
16	13938	14127	14318	-3.93	-1.34	1.35	-0.34	0.34
17	13407	13584	13762	-3.91	-1.30	1.31	-0.33	0.33
18	12899	13064	13230	-3.89	-1.26	1.27	-0.33	0.32
19	12413	12567	12721	-3.87	-1.23	1.23	-0.32	0.32
20	11947	12091	12235	-3.85	-1.19	1.19	-0.31	0.31
21	11502	11636	11770	-3.83	-1.15	1.15	-0.30	0.30
22	11075	11200	11325	-3.81	-1.11	1.11	-0.29	0.29
23	10667	10782	10898	-3.79	-1.07	1.08	-0.28	0.28
24	10275	10383	10491	-3.77	-1.04	1.04	-0.28	0.28
25	9900	10000	10100	-3.75	-1.00	1.00	-0.27	0.27
26	9533	9633	9733	-3.73	-1.04	1.04	-0.28	0.28
27	9182	9282	9382	-3.71	-1.07	1.08	-0.29	0.29

28	8846	8945	9045	-3.69	-1.11	1.11	-0.30	0.30
29	8523	8622	8721	-3.67	-1.15	1.15	-0.31	0.31
30	8214	8313	8411	-3.65	-1.18	1.19	-0.33	0.32
31	7918	8016	8114	-3.63	-1.22	1.22	-0.34	0.34
32	7634	7731	7828	-3.61	-1.25	1.26	-0.35	0.35
33	7362	7458	7554	-3.59	-1.29	1.30	-0.36	0.36
34	7100	7196	7291	-3.57	-1.33	1.33	-0.37	0.37
35	6849	6944	7039	-3.55	-1.36	1.37	-0.39	0.38
36	6609	6702	6796	-3.53	-1.40	1.40	-0.40	0.40
37	6378	6470	6563	-3.51	-1.43	1.44	-0.41	0.41
38	6156	6247	6340	-3.49	-1.46	1.48	-0.42	0.42
39	5943	6033	6125	-3.48	-1.50	1.51	-0.43	0.43
40	5738	5828	5918	-3.46	-1.53	1.55	-0.45	0.44
41	5542	5630	5719	-3.44	-1.57	1.58	-0.46	0.46
42	5353	5440	5528	-3.42	-1.60	1.62	-0.47	0.47
43	5172	5258	5345	-3.40	-1.63	1.65	-0.49	0.48
44	4998	5082	5168	-3.39	-1.67	1.69	-0.50	0.49
45	4830	4913	4998	-3.37	-1.70	1.72	-0.51	0.50
46	4669	4751	4834	-3.35	-1.73	1.75	-0.52	0.52
47	4514	4595	4677	-3.33	-1.77	1.79	-0.54	0.53
48	4365	4445	4526	-3.32	-1.80	1.82	-0.55	0.54
49	4221	4300	4380	-3.30	-1.83	1.86	-0.56	0.56
50	4083	4161	4239	-3.28	-1.86	1.89	-0.58	0.57
51	3950	4027	4104	-3.27	-1.90	1.92	-0.59	0.58
52	3823	3898	3974	-3.25	-1.93	1.96	-0.60	0.59
53	3699	3773	3848	-3.23	-1.96	1.99	-0.62	0.61
54	3581	3654	3728	-3.22	-1.99	2.02	-0.63	0.62
55	3467	3538	3611	-3.20	-2.02	2.05	-0.64	0.63
56	3357	3427	3499	-3.18	-2.05	2.09	-0.66	0.65
57	3251	3320	3390	-3.17	-2.09	2.12	-0.67	0.66
58	3149	3217	3286	-3.15	-2.12	2.15	-0.68	0.67
59	3050	3117	3185	-3.14	-2.15	2.18	-0.70	0.68
60	2956	3021	3088	-3.12	-2.18	2.22	-0.71	0.70
61	2864	2929	2995	-3.10	-2.21	2.25	-0.72	0.71
62	2776	2840	2904	-3.09	-2.24	2.28	-0.74	0.72
63	2691	2753	2817	-3.07	-2.27	2.31	-0.75	0.74
64	2609	2670	2733	-3.06	-2.30	2.34	-0.77	0.75
65	2530	2590	2652	-3.04	-2.33	2.37	-0.78	0.77
66	2453	2513	2573	-3.03	-2.36	2.40	-0.79	0.78

67	2380	2438	2497	-3.01	-2.39	2.44	-0.81	0.79
68	2309	2366	2424	-3.00	-2.42	2.47	-0.82	0.81
69	2240	2296	2354	-2.98	-2.45	2.50	-0.84	0.82
70	2174	2229	2285	-2.97	-2.47	2.53	-0.85	0.83
71	2110	2164	2219	-2.95	-2.50	2.56	-0.87	0.85
72	2048	2101	2155	-2.94	-2.53	2.59	-0.88	0.86
73	1988	2040	2094	-2.92	-2.56	2.62	-0.90	0.88
74	1930	1982	2034	-2.91	-2.59	2.65	-0.91	0.89
75	1875	1925	1977	-2.89	-2.62	2.68	-0.93	0.90
76	1821	1870	1921	-2.88	-2.65	2.71	-0.94	0.92
77	1769	1817	1867	-2.87	-2.67	2.74	-0.95	0.93
78	1718	1766	1815	-2.85	-2.70	2.77	-0.97	0.95
79	1670	1717	1765	-2.84	-2.73	2.80	-0.98	0.96
80	1623	1669	1716	-2.82	-2.76	2.82	-1.00	0.98
81	1577	1622	1669	-2.81	-2.78	2.85	-1.02	0.99
82	1533	1577	1623	-2.80	-2.81	2.88	-1.03	1.01
83	1490	1534	1579	-2.78	-2.84	2.91	-1.05	1.02
84	1449	1492	1536	-2.77	-2.87	2.94	-1.06	1.03
85	1409	1451	1494	-2.76	-2.89	2.97	-1.08	1.05
86	1371	1412	1454	-2.74	-2.92	3.00	-1.09	1.06
87	1333	1374	1415	-2.73	-2.95	3.02	-1.11	1.08
88	1297	1337	1378	-2.72	-2.97	3.05	-1.12	1.09
89	1262	1301	1341	-2.70	-3.00	3.08	-1.14	1.11
90	1228	1267	1306	-2.69	-3.02	3.11	-1.15	1.12
91	1195	1233	1272	-2.68	-3.05	3.14	-1.17	1.14
92	1164	1200	1238	-2.67	-3.08	3.16	-1.19	1.15
93	1133	1169	1206	-2.65	-3.10	3.19	-1.20	1.17
94	1103	1138	1175	-2.64	-3.13	3.22	-1.22	1.18
95	1074	1109	1145	-2.63	-3.15	3.25	-1.23	1.20
96	1046	1080	1115	-2.62	-3.18	3.27	-1.25	1.22
97	1019	1052	1087	-2.60	-3.20	3.30	-1.27	1.23
98	992	1025	1059	-2.59	-3.23	3.33	-1.28	1.25
99	967	999	1033	-2.58	-3.25	3.35	-1.30	1.26
100	942	974	1007	-2.57	-3.28	3.38	-1.32	1.28
101	918	949	981	-2.56	-3.30	3.41	-1.33	1.29
102	894	925	957	-2.54	-3.33	3.43	-1.35	1.31
103	872	902	933	-2.53	-3.35	3.46	-1.37	1.32
104	850	880	910	-2.52	-3.38	3.49	-1.38	1.34
105	829	858	888	-2.51	-3.40	3.51	-1.40	1.36

106	808	836	866	-2.50	-3.43	3.54	-1.42	1.37
107	788	816	845	-2.49	-3.45	3.56	-1.43	1.39
108	768	796	824	-2.47	-3.47	3.59	-1.45	1.40
109	749	777	805	-2.46	-3.50	3.61	-1.47	1.42
110	731	758	785	-2.45	-3.52	3.64	-1.48	1.44
111	713	739	766	-2.44	-3.55	3.67	-1.50	1.45
112	696	722	748	-2.43	-3.57	3.69	-1.52	1.47
113	679	704	730	-2.42	-3.59	3.72	-1.54	1.49
114	663	688	713	-2.41	-3.62	3.74	-1.55	1.50
115	647	671	696	-2.40	-3.64	3.77	-1.57	1.52
116	631	655	680	-2.39	-3.66	3.79	-1.59	1.53
117	616	640	664	-2.37	-3.68	3.81	-1.61	1.55
118	602	625	649	-2.36	-3.71	3.84	-1.62	1.57
119	588	610	634	-2.35	-3.73	3.86	-1.64	1.58
120	574	596	619	-2.34	-3.75	3.89	-1.66	1.60
121	560	582	605	-2.33	-3.78	3.91	-1.68	1.62
122	547	569	591	-2.32	-3.80	3.94	-1.70	1.64
123	535	556	578	-2.31	-3.82	3.96	-1.71	1.65
124	522	543	565	-2.30	-3.84	3.99	-1.73	1.67
125	510	531	552	-2.29	-3.86	4.01	-1.75	1.69

