

SINLOON®

肖特基二極管

Case: TO-263

SB820DC - SB8100DC

8.0A Surface Mount Dual Schottky Barrier Rectifier

Feature

- ◆ Schottky Barrier Chip
- ◆ Guard Ring Die Construction For Transient Protection
- ◆ Low Forward Voltage Drop
- ◆ Low Power Loss, High Efficiency
- ◆ High Surge Current Capability
- ◆ For Use in Low Voltage, High Frequency Inverters, Free Wheeling and Polarity Protection Applications.

Figure



Mechanical Data

- ◆ Case: D²PAK/TO-263, Molded Plastic
- ◆ Terminals: Plated Leads Solderable per MIL-STD-202, Method 208
- ◆ Polarity: See Diagram
- ◆ Weight: 1.7 grams (approx)
- ◆ Mounting Position: Any
- ◆ Marking: Type Number
- ◆ Lead Free: For RoHS / Lead Free Version Add "-LF" Suffix to part Number.

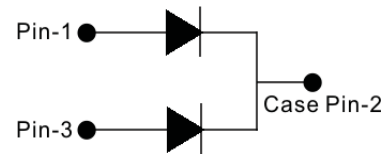

Dimension

Case: D²PAK/TO-263 (mm)

Dim.	Min.	Max.
A	9.8	10.4
B	9.6	10.6
C	4.4	4.8
D	8.5	9.1
E	2.8	---
G	1.0	1.4
H	---	0.9
J	1.2	1.4
K	0.3	0.7
P	2.35	2.75

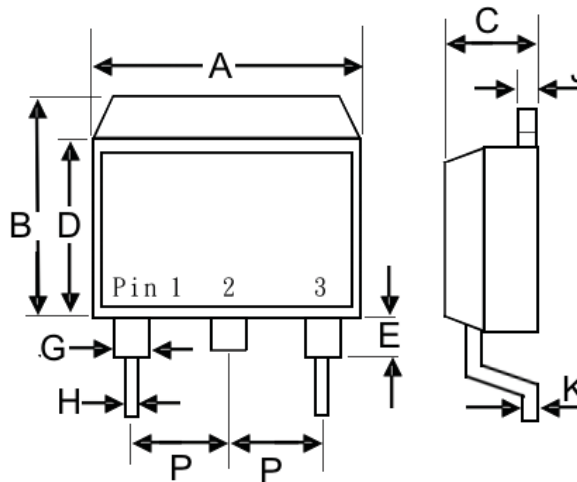

Marking Information

- SB8xxCT = Device Number
- xx = See Page 2 SB Part
- Polarity = As Marked Body



Recommended Footprint

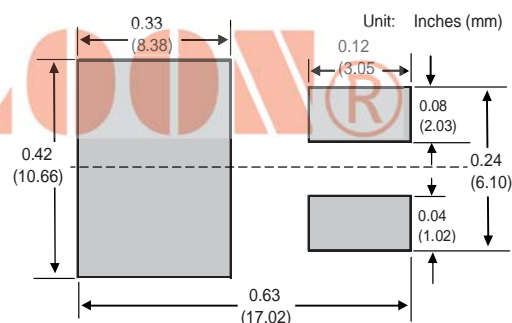

SINLOON®

肖特基二極管

SB820DC - SB8100DC

Case: TO-263 1.0A Surface Mount Dual Schottky Barrier Rectifier

Maximum Ratings and Electrical Characteristics @T_A=25°C unless otherwise specified

Single Phase, half wave, 60Hz, resistive or inductive load For capacitive load, derate current by 20%.

Characteristics	Symbol	SB	SB	SB	SB	SB	SB	SB	SB	Unit
		820DC	830DC	840DC	745DC	850DC	860DC	880DC	8100DC	
Peak Repetitive Reverse Voltage	V _{RRM}									V
Working Peak Reverse Voltage	V _{RWM}	20	30	40	45	50	60	80	100	V
DC Blocking Voltage	V _R									V
RMS Reverse Voltage	V _{R(RMS)}	14	21	28	32	35	42	56	70	V
Average Rectified Output Current @T _C =130°C	I _O	8.0			8.0			8.0		A
Non-Repetitive Peak Forward Surge Current 8.3ms Single half sine-wave superimposed on rated load (JEDEC)	I _{FSM}	150			150			150		A
Forward Voltage @I _F =4.0A	V _{FM}	0.55			0.75			0.85		V
Peak Reverse Current @T _A = 25°C	I _{RM}	0.5								mA
At Rated DC Blocking Vol. @T _A =100°C		50								
Typical Junction Capacitance (Note 1)	C _J	400								pF
Typical Thermal Resistance (Note 2)	R _{θJC}	3.0								°C/W
Operating and Storage Temperature Range	T _J , T _{STG}	-65 to +150								°C

Note 1: Measured at 1.0 MHz and applied reverse voltage of 4.0V D.C.

Note 2: Mounted on minimum recommended pad size on FR-4 board.

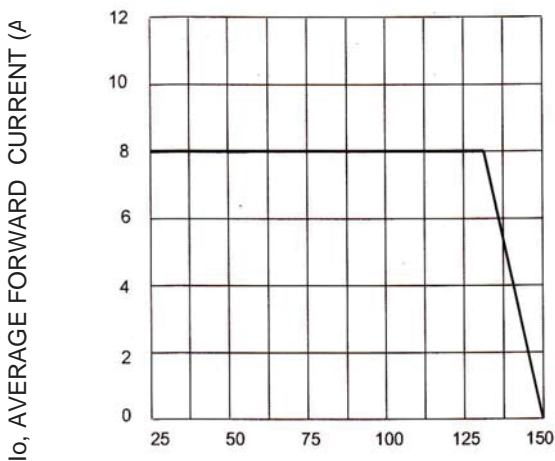

Fig-1 Forward and Current Derating Curve

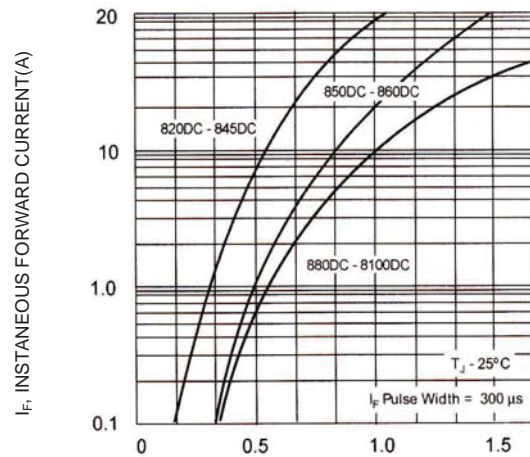

Fig-2 Typical Forward Characteristics

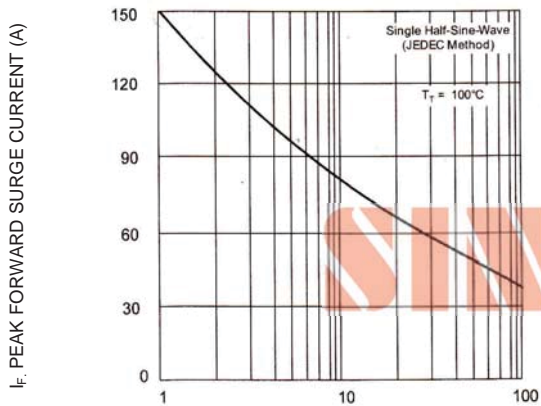

Fig-3 Maximum Non-Repetitive Peak FWD Surge Current

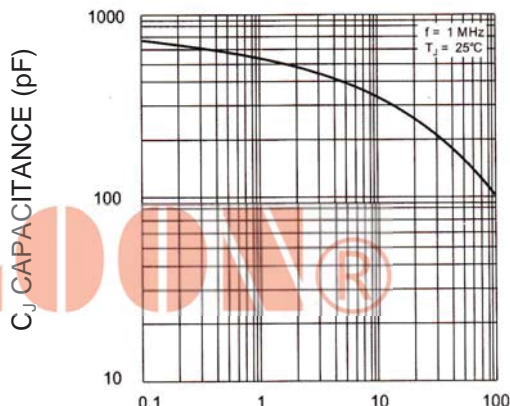

Fig-4 Typical Junction Capacitance

SINLOON®

肖特基二極管

SB820DC - SB8100DC

Case: TO-263

8.0A Surface Mount Dual Schottky Barrier Rectifier

Packaging Information

Reel Dimension (mm)	Quantity (Pcs)	Inner Box Size LxWxH (mm)	Quantity (Pcs)	Carton Size LxWxH (mm)	Quantity (Pcs)	Gross Weight
330	800	340x337x45	1600	370x370x420	6400	15Kg

Note: 1. Paper reel. White or gray color,
2. Components are packed in accordance with EIA standard 481-1 and 481-2

Paper Tape

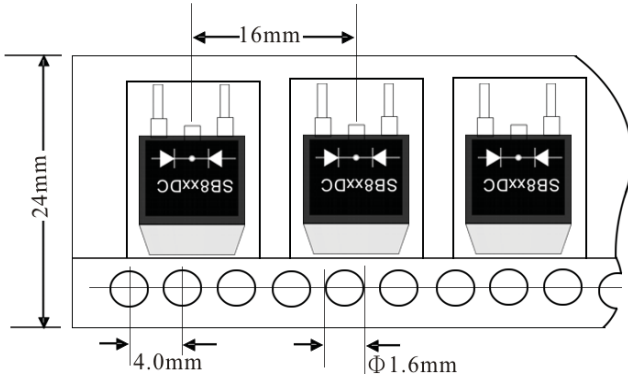

Reel Package

Size: 330 mm

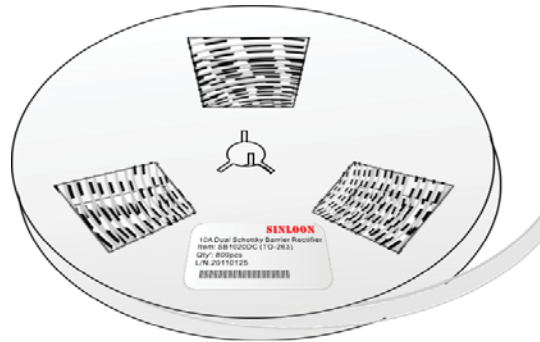

Inner Box

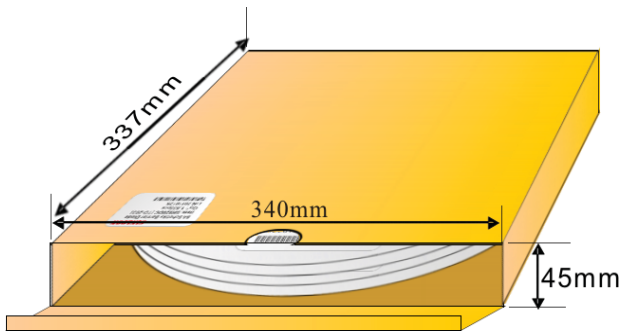

Cartons Package



Carton Size: 370x370x420 mm

SINLOON®

※美隆公司產品規格及其特性參數的改變或更新恕不另行通知。

※Mayloon characteristic parameters of electronic product specification changes or updates without notice to improve。

